

RCTi and RCTi-3ph Technical Notes

All measuring instruments are subject to limitations. The purpose of these technical notes is to explain some of those limitations and to help the engineer maximise the many advantages of PEM's Rogowski current transducers.

These technical notes should be read in conjunction with the RCTi and RCTi-3ph short-form datasheets.



Contents

1. Basic operation	3
2. What are the advantages of the RCTi and RCTi-3ph over current transformers?	4
3. Accuracy and Calibration	5
3.1 Calibration.....	5
3.2 Accuracy with current magnitude – linearity and internally generated noise	5
3.2.1 Low frequency noise	5
3.2.2 DC offset.....	6
3.2.3 Linearity.....	6
3.3 Positional Accuracy	7
3.4 Rejecting external currents.....	8
3.5 Voltage interference	8
3.6 Temperature	9
4. Rated current, overloads and saturation.....	11
4.1 Peak di/dt.....	11
4.2 Absolute maximum (peak) di/dt.....	11
4.3 Absolute maximum (rms) di/dt.....	12
5. Frequency response.....	13
5.1 Low frequency (including phase error at 50/60Hz)	13
5.2 High frequency.....	14
5.3 Response time (step response).....	15
6. Output cabling and loading	16
7. Product safety and standards.....	17
7.1 How does PEM rate the voltage insulation of its Rogowski coils?	17
7.2 Product safety and EMC compliance	17

Figures

<i>Figure 1. Basic Operation.....</i>	<i>3</i>
<i>Figure 2. High frequency check.....</i>	<i>5</i>
<i>Figure 3. Noise and DC offset of the RCTi and RCTi-3ph</i>	<i>6</i>
<i>Figure 4. Linearity of the RCTi.....</i>	<i>6</i>
<i>Figure 5. Positional accuracy variation.....</i>	<i>7</i>
<i>Figure 6. Percentage of external current measured by the RCTi.....</i>	<i>8</i>
<i>Figure 7. Voltage interference for an RCTi/250A mounted on an 80mm by 2mm busbar at 1.41kVrms</i>	<i>9</i>
<i>Figure 8. Temperature coefficient of RCT coil (1m cable)</i>	<i>10</i>
<i>Figure 9. Recovery from saturation RCTi/2000A – Timebase 1sec/div</i>	<i>11</i>
<i>Figure 10. Safe operating area for the RCTi and RCTi-3ph for a sinusoidal current</i>	<i>12</i>
<i>Figure 11. Low frequency bode plots of the RCTi for various current ratings</i>	<i>13</i>
<i>Figure 12. Examples of the hf response of the RCTi with different coil and cable lengths</i>	<i>14</i>
<i>Figure 13. Response time of the RCTi</i>	<i>15</i>

1. Basic operation

The RCTi is an ac current transducer. It comprises a thin, flexible, clip-around sense coil (a Rogowski coil), which is connected to an electronic integrator housed in a DIN rail mount electronics enclosure.

The voltage induced in a Rogowski coil is proportional to the **rate of change** of current enclosed by the coil-loop. It is therefore necessary to **integrate** the Rogowski coil voltage in order to produce a voltage proportional to the current.

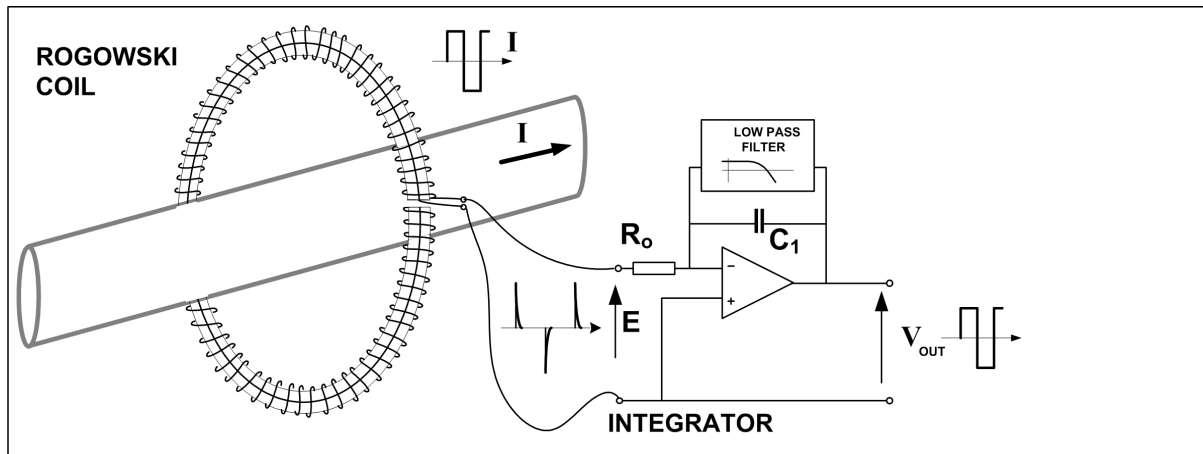

Figure 1. Basic Operation

The coil is uniformly wound with N turns/m on a non-magnetic former of constant cross section area A m². If formed into a closed loop then the voltage e induced in the coil is given by the equation:

$$e = \mu_0 N A \frac{di}{dt} = H \frac{di}{dt}$$

where H (Vs/A) is the coil sensitivity and I is the current to be measured passing through the loop.

The loop does not need to be circular and e is independent of the current position in the loop. To reproduce the current waveform as a measurement signal which can be displayed on an oscilloscope or quantified using a DVM, all that is required is a means for accurately integrating the coil voltage, such that:

$$V_{out} = (1/T_i) \int e \cdot dt = R_{sh} \cdot I$$

where $T_i = R_o C_1$ and $R_{sh} = H/T_i$ is the transducer sensitivity in (V/A).

2. What are the advantages of the RCTi and RCTi-3ph over current transformers?

Like a current transformer (CT), the RCTi and RCTi-3ph do not measure the direct current component, they only measure the alternating components. However unlike CTs, the RCTi and RCTi-3ph ac current transducers:

- ✓ **...are intrinsically safe devices.** There is no danger of an open circuit secondary.
- ✓ **...can take large current overloads without damage** (provided the di/dt ratings are not exceeded – see Section 4)
- ✓ **...do not suffer from magnetic saturation so are very linear** (see Section 3.2.3)
- ✓ **... the size of the Rogowski coil can be chosen independently of the current magnitude.** This is unlike other current transducers which become bulkier as the current magnitude increases. For currents of several kA's or more there is really no better alternative than the Rogowski transducer!
- ✓ **...are very easy to use** - the coil is thin, flexible and easy to insert around a current carrying device. Ideal for retrofit applications.
- ✓ **...are non-intrusive.** They draw no power from the main circuit carrying the current to be measured. The impedance injected into the main circuit due to the presence of the transducer is only a few pico-Henrys!
- ✓ **...have a wide (-3dB) bandwidth,** from 0.6Hz to typically > 500kHz.
- ✓ **...have a small, known, phase error, for power measurements at 45/65Hz and above.** Ideal for power measurement or power quality monitoring.
- ✓ **...provide an isolated measurement at ground potential** similar to other current transducers (except coaxial shunts) i.e. there is no direct electrical connection to the main circuit.
- ✓ **...can measure AC signals superimposed on large DC.** The transducer does not measure direct currents - as a result it can measure small AC currents in the presence of a large DC component

3. Accuracy and Calibration

3.1 Calibration

The primary calibration is at 50Hz. PEM has the capability of generating highly stable sinusoidal currents up to 5000A from 15Hz to 1kHz, and 1000A from 15Hz to 10kHz. The RCTi Rogowski current transducer is very linear with current magnitude as shown in Section 3.2, thus a single point calibration for the RCTi is considered sufficient.

As a final functional check the RCTi is tested with a pulsed current with fast transient edges similar to that shown in Figure 2 below. The pulse test provides a check that the high frequency performance of the RCTi is within specification.

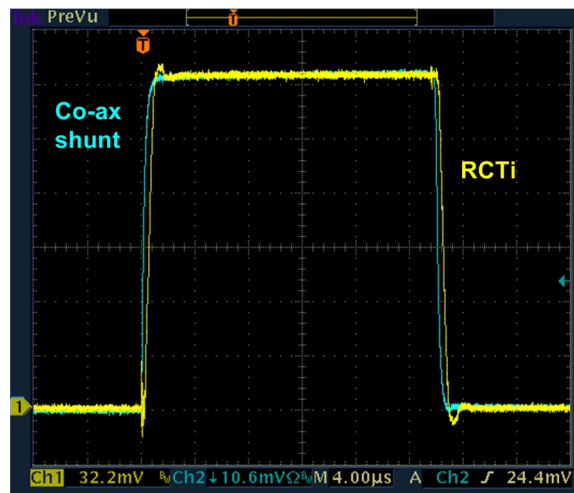

Figure 2. High frequency check
 Ch1 – RCTi/250A with 1m cable, 700mm coil
 Ch2 – Co-axial shunt hf(-3dB) 800MHz
 Time-base 4.0µs/div

Every RCTi and RCTi-3ph is supplied with a calibration certificate. The certificate contains details of all measurement devices and recording equipment used in the calibration including reference to their traceable United Kingdom Accreditation Service (UKAS) calibration certificates. A copy of our traceability chart is available on request.

3.2 Accuracy with current magnitude – linearity and internally generated noise

On the RCTi datasheet, ‘typical accuracy’ is defined for 5 to 150% full-scale. The lower limit of 5% is very conservative.

When measuring currents below 5% of full scale both the low frequency noise and the DC offset can affect the accuracy of the measurement.

3.2.1 Low frequency noise

The integrator op-amp generates random low frequency noise (often called $1/f$ noise). This noise is distributed around the low frequency bandwidth f_L where the integrator gain is at a maximum. The magnitude of this noise is proportional to $1/f_L H$ where H is the coil sensitivity in (Vs/A).

Figure 3. shows the typical low frequency noise for a 250A rated RCTi. This noise reduces as the current rating of the RCTi increases. The peak to peak noise values are listed in the table associated with Figure 3.

3.2.2 DC offset

The output from the electronic integrator is decoupled into a buffer amplifier. The mean output should ideally be zero but in practice there is a small DC offset. The maximum DC offset at the output of the RCTi are listed in the table associated with Figure 3.

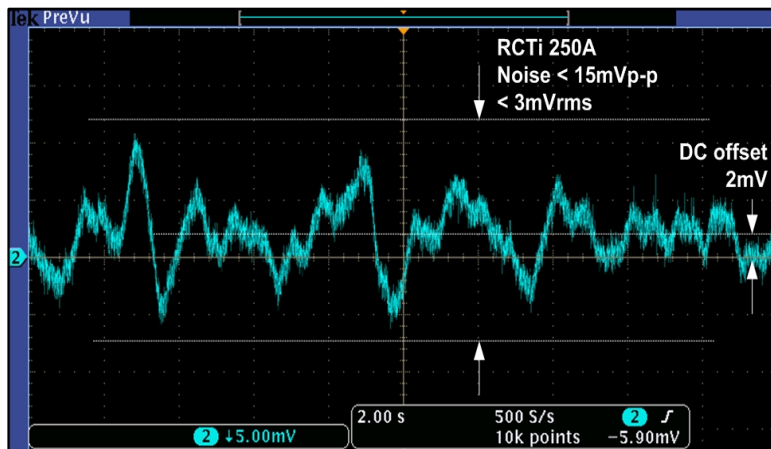

Current rating A (rms)	Noise (mVp-p)	DC offset max @ 65°C (mV)
250	15.0	5.0
500	10.0	4.0
750	10.0	3.0
1000	10.0	3.0
1500	10.0	3.0
2000	7.5	6.0
2500	7.5	5.0
> 4000	5.0	4.0

Figure 3. Noise and DC offset of the RCTi and RCTi-3ph

3.2.3 Linearity

Linearity error is the difference ΔI between the true current value, I , and the measured value V_{out}/R_{SH} (where R_{SH} is the sensitivity in V/A). For a fixed frequency and fixed current position the linearity error will vary with the current magnitude over the rated current of the RCTi.

Rogowski current transducers contain no magnetic materials. Therefore there are no saturation or non-linear effects associated with the magnitude of the current. Additionally the integrator gain is set by highly stable low drift passive components which ensure excellent linearity.

As an example, linearity was measured by varying a sinusoidal current source such that the RCTi measured from 5% to rated current. The linearity was measured at 50Hz. Two RCTi models were tested, the RCTi/250A and the RCTi/2000A.

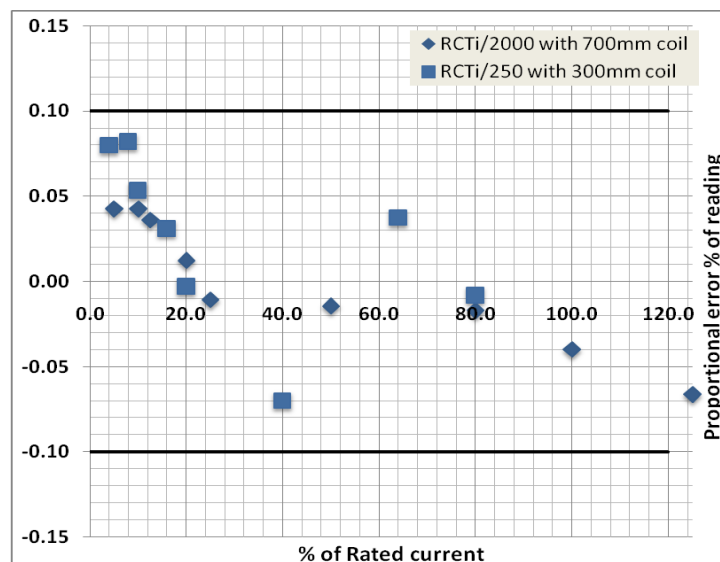

Figure 4. Linearity of the RCTi

The comparative measurement device is a current transformer, having a traceable UKAS calibration certificate across the current range. The measurements are compared on a Keithley model 2000 DMM, having a traceable

UKAS calibration certificate. The number of ampere turns through the Rogowski coil and through the current transformer is arranged such that the DMM is used only to compare two substantially equal voltages. Thus the accuracy of the DMM is not relevant. Taking into account the specified uncertainty and the typical calibration drift over one year, the estimated uncertainty for the calibrated sensitivity (V/A) of the current transformer is $\pm 0.1\%$.

From the results in the scatter graph of Figure 4, the linearity was found to be better than $\pm 0.1\%$ of actual reading. The linearity is almost certainly better than this since the accuracy of measuring the current is of the same order as the differences.

3.3 Positional Accuracy

Due to small variations in the winding density and coil cross sectional area the transducer output varies slightly depending on the position of the current in the Rogowski coil and also the size of the current conductor relative to the coil.

PEM have developed an accurate method of manufacturing Rogowski coils which keeps this positional variation to a minimum.

To quantify this variation tests were performed with two different coil circumferences, 300mm and 700mm, and two different conductor diameters 10mm and 50mm, the results are shown in Figure 5.

Where the Tables mention '700mm (x2)' the Rogowski coil was wrapped twice around the conductor.

The RCTi is calibrated with the conductor central in the coil, position 1, to an accuracy of $\pm 0.2\%$. The values listed in the tables are an additional uncertainty due to the conductor position. The results are all worst case of the total batch of six coils tested.

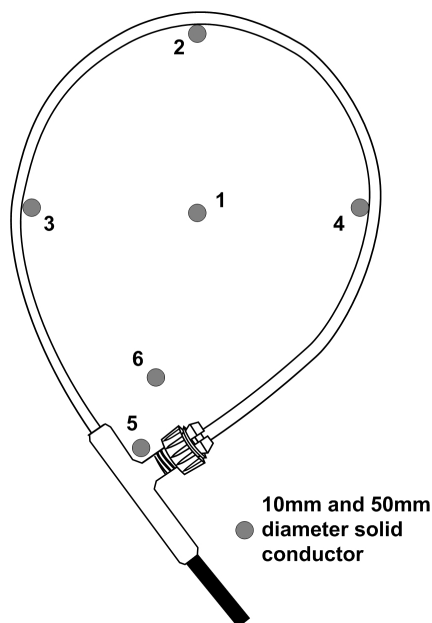

Coil length (mm)	Positional error % of reading -10mm conductor				
	Touching the edge of the coil			Ferrule	3cm from ferrule
	2	3	4	5	6
300	± 1	± 1	± 1	-3.5	-0.75
700	± 1.5	± 2.0	± 2.0	-3.5	-1
700 (x2)	± 0.5	± 0.5	± 0.5	-1.5	-0.5

Coil length (mm)	Positional error % of reading - 50mm conductor			
	Touching the edge of the coil			Ferrule
	2	3	4	5
300	± 0.5	± 0.5	± 0.5	-0.5
700	± 1	± 1	± 1	-1
700 (x2)	± 0.3	± 0.3	± 0.3	-0.3

Figure 5. Positional accuracy variation

The results can be summarised as follows:

- For both coil lengths the variation of accuracy with conductor position improves as the size of the conductor increases relative to the Rogowski coil area.

- The positional variation is always at its worst where the coil clips together, every effort must be made to keep the conductor away from this area.
- Wrapping the Rogowski coil twice around a given conductor greatly improves the positional variation (i.e. comparing the 300mm and the 700mm (x2) results). However it should be noted that wrapping the coil twice around the conductor also halves the rated current and doubles the sensitivity (V/A).

From these results we derive the typical accuracy of $\pm 1\%$ of reading quoted on the short-form datasheet.

3.4 Rejecting external currents

Currents external to the Rogowski coil can cause measurement interference.

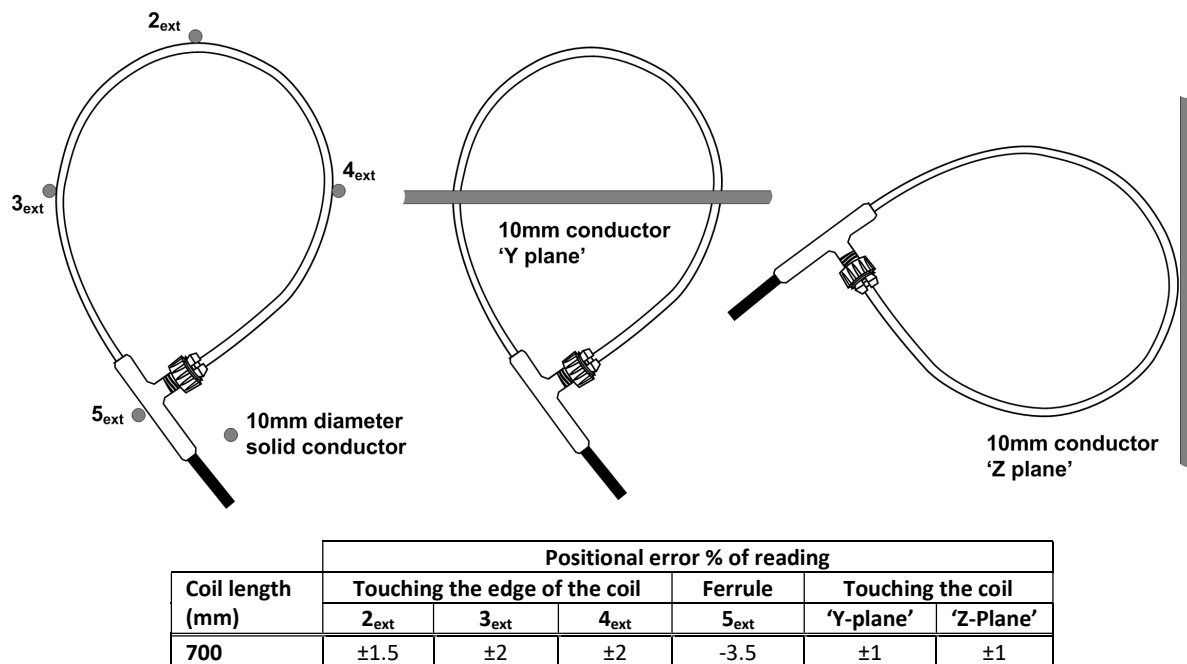

Figure 6. Percentage of external current measured by the RCTi

Figure 6. shows similar conductor positions to those shown in Figure 5, adjacent to the coil edge but this time outside the Rogowski loop. All the tests in Figure 6. were carried out using the 10mm conductor and the 700mm coil and there is a very similar error of reading to those specified in equivalent positions in Figure 5. This is worst case, a 10mm conductor represents only 2% of the Rogowski coil area (point source of current).

The RCTi will often be installed in areas where conductors external to the Rogowski coil are in alternate planes to those shown in Figure 6. The RCTi coil has a cancellation loop which greatly reduces its susceptibility to these currents keeping the external pick-up to typically $\pm 1\%$ in the 'Y and Z-plane' positions shown.

If the external current (outside the coil loop) is much greater than the current being measured (inside the coil loop) then the error may be significant. This is particularly relevant if the external current is flowing in a nearby multi-turn coil.

3.5 Voltage interference

Rogowski coils are susceptible to voltage pick-up through capacitive coupling onto the Rogowski coil winding. For a given Rogowski coil this pick-up gets worse as the rated current of the unit decreases and the sensitivity (V/A) increases.

PEM has published significant research into resolving this problem. The RCT range of Rogowski coils has been optimised to attenuate any voltage interference. As an example a RCTi/250A rated unit with 300mm coil is placed on a bus-bar connected to the open circuit secondary of a high voltage transformer as per Figure 7. The bus-bar voltage is increased to 1.41kVrms / 2kV peak. The 'pick-up error' is only 10mVp-p (3mVrms or 0.06% of rated output).

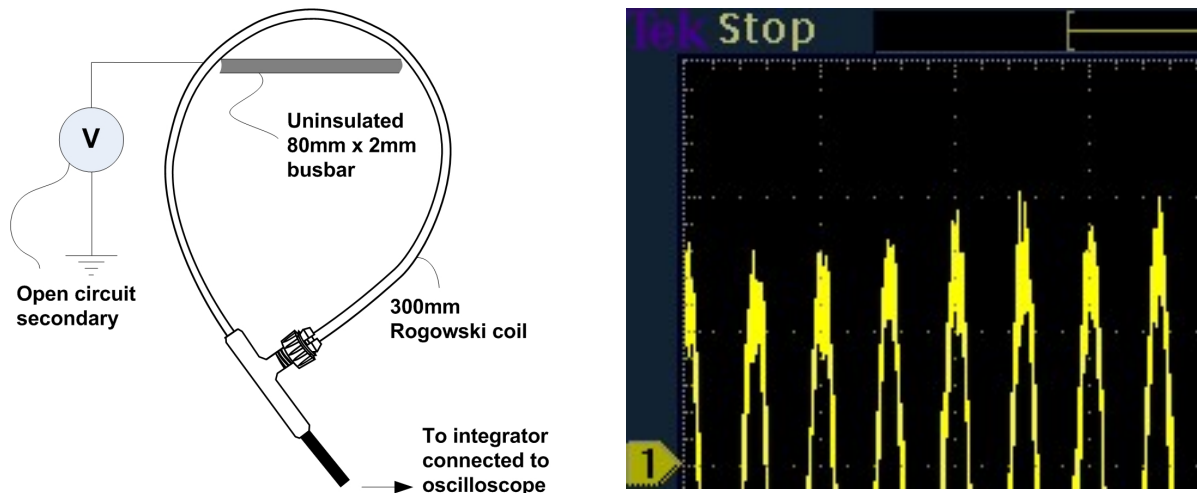

Figure 7. Voltage interference for an RCTi/250A mounted on an 80mm by 2mm busbar at 1.41kVrms

If the voltage close to the coil is subject to high rates of change (e.g. several 100V/ μ s or high frequency oscillations in the MHz range) then a larger interference can occur.

As a check for the effect of external voltages or currents the user should place the Rogowski coil in approximately the same position as used for measuring the desired current, but not looped around the desired current. Ideally there should be no measured signal. If there is interference then the same interference will be superimposed on the current waveform when it is measured and this can be taken into account when interpreting the measurement.

3.6 Temperature

The variation in accuracy of the RCTi with temperature results from

1. Expansion of the plastic former onto which the Rogowski coil is wound. This reduces the sensitivity of the Rogowski coil.
2. Drift with temperature of the passive component values that set the integrator time constant

To overcome these problems the Rogowski coil is wound onto a plastic former with a very low co-efficient of expansion. High stability resistors and capacitors set the integrator time constant.

Rogowski Coil Temperature Coefficient

A sample batch of Rogowski coils have been tested from -40 to 80°C inside a temperature controlled environment (Vötsch VT4002 chamber). The coils inside the chamber measure a known current and the sensitivities (Vs/A) of the coils are recorded at each temperature interval.

The results of six coils are shown in Figure 8.

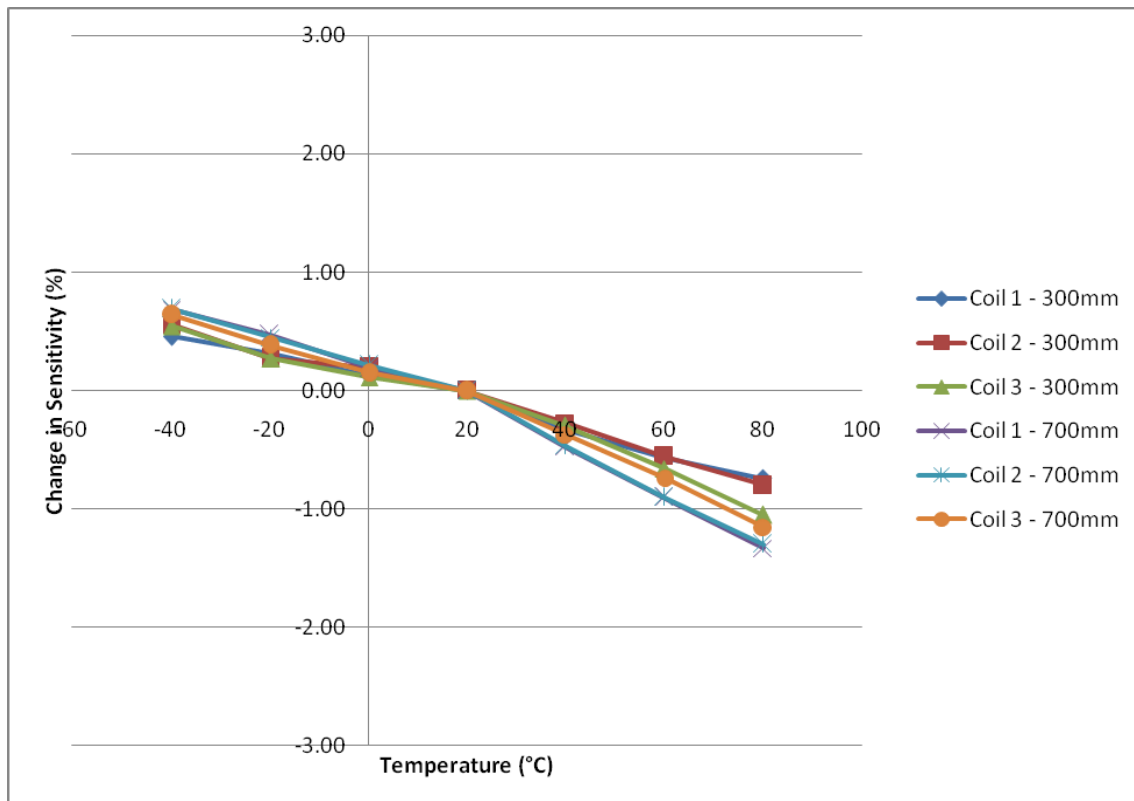

Figure 8. Temperature coefficient of RCT coil (1m cable)

The temperature coefficient of the Rogowski coil varies with coil length. The temperature coefficients which best describe the measured results shown in Figure 8. are given in the table below:

	Temperature Coefficient (ppm/°C)	
	-40°C to +20°C	+20 to +80°C
300mm coil, 1m cable	-90	-150
700mm coil, 1m cable	-110	-210

The temperature coefficient will vary with coil and cable length, please contact PEM for more information about longer coils and cables.

Integrator Temperature Coefficient

The integrator sensitivity is set using a number of passive components which are selected for their low temperature drift. The temperature coefficient for the RCTi integrator is given in the table below:

	Temperature Coefficient (ppm/°C)	
	-40°C to +20°C	+20 to +80°C
Integrator time constant, Ti	±90	±90

The overall measurement uncertainty can thus be calculated from the sum of the Rogowski coil and integrator time constant temperature coefficients.

4. Rated current, overloads and saturation

The RCTi has an output of 5Vrms corresponding to the rated current. If the peak current exceeds 150% of this rating the integrator will saturate and the measured waveform will be completely corrupted (unlike an amplifier for which the output waveform is merely clipped).

Exceeding the peak current rating will not damage the RCTi provided the di/dt ratings are not exceeded. It will return to normal operation after the current surge has passed.

The time it takes for the transducer to return to normal operation once the surge has passed is dependent on the low frequency bandwidth of the RCTi. For example Figure 9. shows the recovery of an RCTi/2000A from saturation. The RCTi measures a short duration (<2 μ s) impulse of 5000A which is sufficient to cause saturation. The RCTi/2000A has a low frequency bandwidth $f_L = 0.2\text{Hz}$ and it takes the transducer approximately 4.0s to recover from saturation, where recovery time is define as $0.8/f_L$.

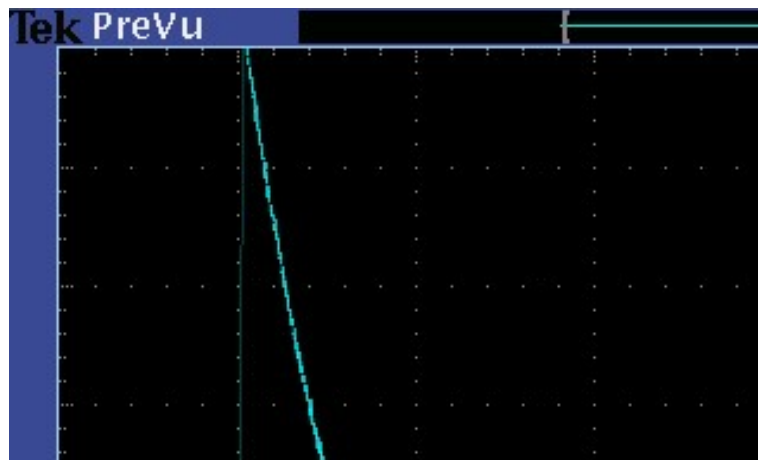

*Figure 9. Recovery from saturation RCTi/2000A – Timebase 1sec/div
Ch2 – Output from the RCTi/2000A transducer 3.0V/div*

4.1 Peak di/dt

This is the maximum di/dt above which the RCTi will fail to correctly measure the current, effectively a slew rate limitation. Values are given in the table below:

Current rating A (rms)	Peak di/dt (kA/ μ s)
250	0.5
500	1.0
750	1.5
1000	2.0
1500	2.5
2000	2.5
2500	3.0
> 4000	6.0

4.2 Absolute maximum (peak) di/dt

The RCTi can be damaged by excessive di/dt due to the voltage generated in the coil.

For the RCTi the **absolute maximum peak di/dt is 6.0kA/ μ s.**

4.3 Absolute maximum (rms) di/dt

The RCTi can be damaged by sufficiently high repetitive di/dt even though the peak di/dt rating is not exceeded. For sinusoidal waveforms the calculation of rms di/dt is:

$$di/dt \text{ rms} = 2\pi f I_{\text{rms}} \text{ (where } f \text{ is the measured frequency and } I_{\text{rms}} \text{ the rms value of the measured current)}$$

For the RCTi the **absolute maximum peak di/dt is 0.3 kA/μs**.

For a sinusoidal current the safe operating area for the RCTi is defined in Figure 10. It must be noted that this is for the standard product, with less than 5m of cable between coil and integrator, and a coil circumference of less than 700mm. Where different coil and cable lengths are specified the absolute maximum rms di/dt may be different.

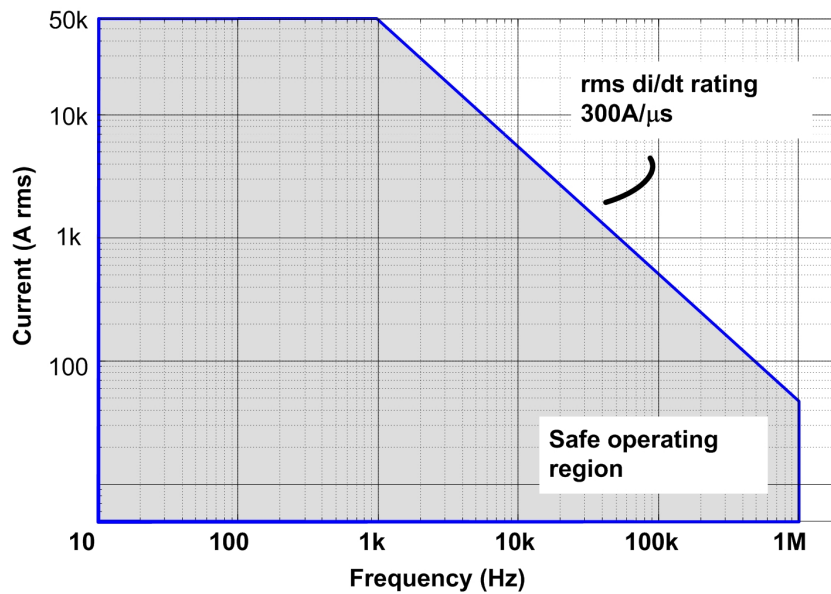

Figure 10. Safe operating area for the RCTi and RCTi-3ph for a sinusoidal current

For non-sinusoidal waveforms of high current / high frequency the user should consult PEM if they are uncertain if RCTi is operating inside the safe operating area.

5. Frequency response

The RCTi has a wide-bandwidth and is optimised to give a flat sensitivity (V/A) and small phase error over a wide range of frequencies.

Where a wider bandwidth is required PEM also offer the CWT range with bandwidths below 0.01Hz and up to 20MHz.

5.1 Low frequency (including phase error at 50/60Hz)

The low frequency bode plot of the RCTi for the various current ratings is included below:

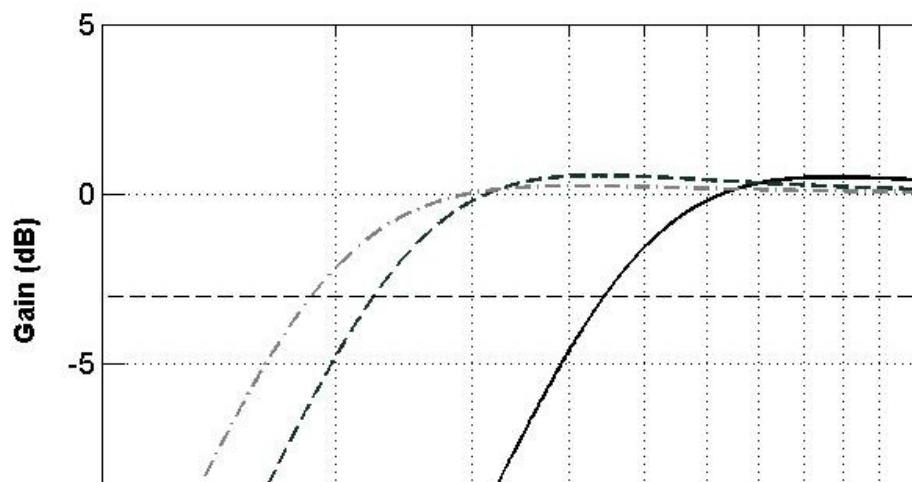

Figure 11. Low frequency bode plots of the RCTi for various current ratings

The low frequency bandwidth of the RCTi is set by high stability passive components, thus the phase error at low frequency is predictable and repeatable to a high tolerance. The table below shows the phase error at a given frequency as the rated current varies:

RCTi model (Rated current) (A)	% of Rated current (%)	Measurement phase error (°) at			
		50Hz	60Hz	400Hz	1000Hz
250 to 1500	150	0.9 (±0.1)			
	100	0.9 (±0.1)	0.75 (±0.08)	0.11	0.05
	20	0.9 (±0.2)			
	5	0.9 (±0.5)			
≥2000	150	0.4 (±0.1)			
	100	0.4 (±0.1)	0.35 (±0.08)	0.06	0.03
	20	0.4 (±0.15)			
	5	0.4 (±0.3)			

From the table it is clear to see an analogy between the RCTi and metering class CTs. From the standard IEC6044-1 which defines the accuracy class of CTs:

- **250 to 1500A** - meets the phase requirements of a **class 1 metering current transformer**.
- **≥2000** - meets the phase requirements of a **class 0.5 metering current transformer**.

5.2 High frequency

Unlike conventional CTs the RCTi has an excellent high frequency (hf) performance. It is therefore useful not only for 50/60Hz measurements but also for medium frequency applications such as MF-DC welding, VSD drive monitoring and induction heating applications. The high frequency bandwidth means that the phase error up to 20kHz is small making the RCTi suitable for measuring power in highly non-linear loads with significant harmonics.

The high frequency bandwidth of the RCTi and RCTi-3ph is in part dependent on:

- The length (circumference) of the Rogowski coil.
- The length of the cable between the coil and the integrator.

Figure 12. shows the typical frequency response of the RCTi/250A for three cases

- 300mm coil and 1m connecting cable.
- 700mm coil and 1m connecting cable.
- 700mm coil and 10m connecting cable.

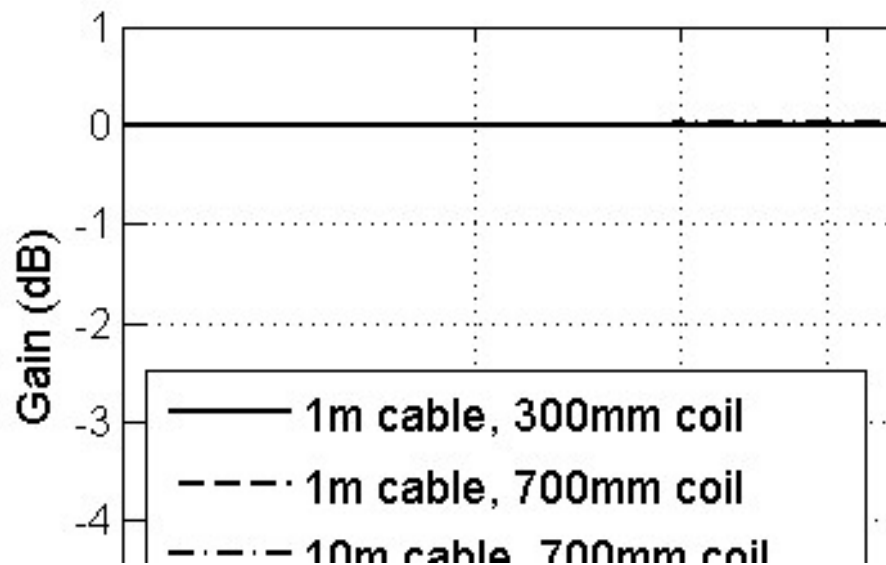

RCTi/250A	Phase error @ 20kHz (°)	High Frequency (-3dB) (MHz)
1m cable, 300mm coil	-1.6	1.2
1m cable, 700mm coil	-2.8	0.7
10m cable, 700mm coil	-5.3	0.3

Figure 12. Examples of the hf response of the RCTi with different coil and cable lengths

PEM have an accurate model of the high frequency performance of the RCTi for all possible combinations of coil and cable length and can provide a frequency response or phase error calculation as necessary.

We have also supplied numerous applications with customised RCTi products with improved high frequency response where required. We also supply the CWT range with hf (-3dB) bandwidths up to 20MHz.

5.3 Response time (step response)

The response time of the RCTi and RCTi-3ph is related to the high frequency bandwidth. Thus the coil and cable length affect the speed of response.

Figure 13. shows the typical transient response of the RCTi/250A with a 1m cable and 300mm coil, the high frequency bandwidth is defined in Figure 12. The reference measurement is a co-axial shunt having a nominal high frequency bandwidth of 800MHz which gives virtually an instantaneous response.

The pulse magnitude is 20A, and the rise-time of the pulse is 1.1 μ s.

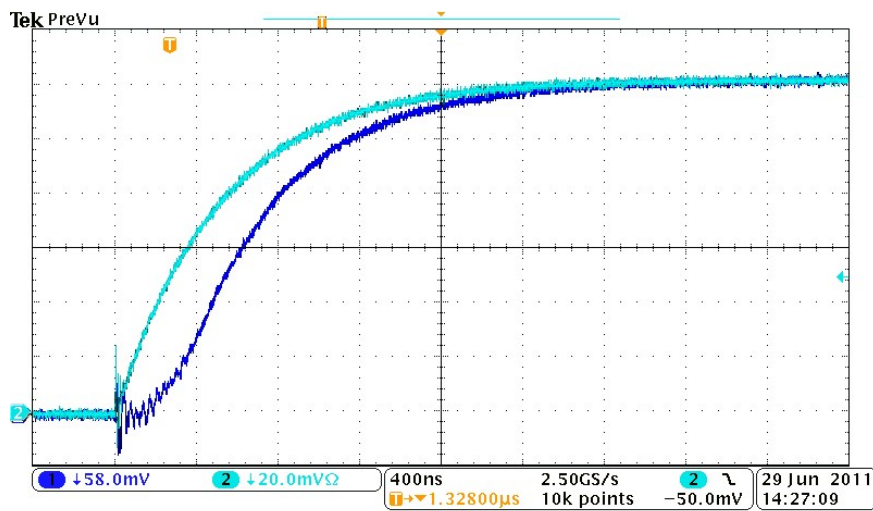

Figure 13. Response time of the RCTi
 Ch1 – RCTi/250A with 1m cable, 300mm coil
 Ch2 – Co-axial shunt, T&M Research
 Time-base 400ns/div

6. Output cabling and loading

The output impedance of the RCTi and RCTi-3ph is 10Ω .

The RCTi and RCTi-3ph must be terminated with an impedance of at least $10k\Omega$ for rated accuracy.

The RCTi (not the RCTi-3ph) can be terminated into an impedance of $\geq 1k\Omega$, however at $1k\Omega$ there is a 1% reduction in the sensitivity (V/A) due to the 10Ω output impedance.

The RCTi and RCTi-3ph cannot be terminated into a 50Ω impedance. The integrator op-amp has insufficient output current capability to drive a 50Ω load.

Third party EMC tests for the RCTi and RCTi-3ph have been carried out (see Section 7.2), these tests assume an output cable length of up to 3m.

Output cables longer than 3m have not been included in the EMC immunity tests and may decrease RF noise immunity. However PEM does not consider the use of extension cables to be problematic from the noise viewpoint provided the recommended cable types are used and care is taken to provide additional screening from noise sources.

The specified performance of the RCTi and RCTi-3ph will be unaffected by longer cable runs $< 30m$. PEM has tested the performance of an RCTi/250A measuring both a 10kHz and a 100kHz, 50A, sinusoidal current, where the output of the RCTi/250A is connected to:

- 30m Belden 8762 screened twisted pair, Time delay=6.8ns/m
- 30m RG58 coaxial cable, Time delay=5ns/m

In both cases the cables were terminated into an oscilloscope with first a $1k\Omega$ and then a $1M\Omega$ load impedance. There was no discernable change in the output magnitude of the RCTi/250A. However as would be expected there is a small change in phase which can be adequately predicted from the quoted time delay for each cable type.

7. Product safety and standards

7.1 How does PEM rate the voltage insulation of its Rogowski coils?

The RCTi is intended for permanent installation on equipment.

Every Rogowski coil supplied by PEM is given a peak voltage insulation rating. The rating is derived from the following test:

The coil is exposed to an AC test voltage = $(2 \times \text{Peak voltage rating (kV)} + 1) / \sqrt{2}$ (kV rms), for 60 seconds at 50Hz. The RCTi is rated at 2kV peak and will be flash tested at 4kVrms (11kV peak to peak), 50Hz, for 1 minute.

The user should visually inspect the Rogowski coil and cable for insulation damage each time the transducer is used. Every Rogowski coil has at least two layers of insulation covering the winding. These are always different colours making visual inspection of the integrity of the insulation easier.

It is imperative that the user grounds the BNC connector from a safety viewpoint so that in the event of an insulation breakdown at the coil (due to exceeding the voltage rating or due to mechanical damage), a fault current path exists via the cable connecting the S2 terminal to ground on the subsequent recording equipment.

As for the majority of plastics, the material used for insulating PEM's Rogowski coils can be damaged by exposure to corona over a reasonably long period of time.

The RCT has been designed for permanent installation and hence continuous exposure to nearby voltages. For voltages to ground of less than 2kV peak (i.e. 1.41kVrms for a sinusoidal voltage), corona effects will be negligible, and continuous operation is permitted.

For voltages to ground of more than 2kV peak the coil must be sufficiently distanced from the high voltage conductor or device, using air and / or insulating materials such that corona does not occur in the vicinity of the coil. Sharp corners should be avoided on the high voltage structures near the Rogowski coil as sharp corners lower the voltage at which corona begins. PEM has no control over how its customers install Rogowski coils, and hence the responsibility for long continuous life when operating in a HV environment lies with the customer.

7.2 Product safety and EMC compliance

The RCT range of current transducers has been designed, assessed and third party tested to ensure they comply with relevant EU standards and all products carry the CE mark of conformity. In addition, the range has been assessed and tested against the relevant FCC CFR regulations. The CE Declaration of Conformity can be found on our website.

All RCT products comply with:

EMC: IEC 61326-1:2013
 FCC Title 47 (CFR:2010, Part 15b)
 Safety: IEC 61010-1:2010; Pollution Degree 2

Refer to the 'Instructions for use' document before use.

